

GEOMETRIA DESCRIPTIVA

Nº:

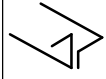

Nombre:

Cód:

Fecha:

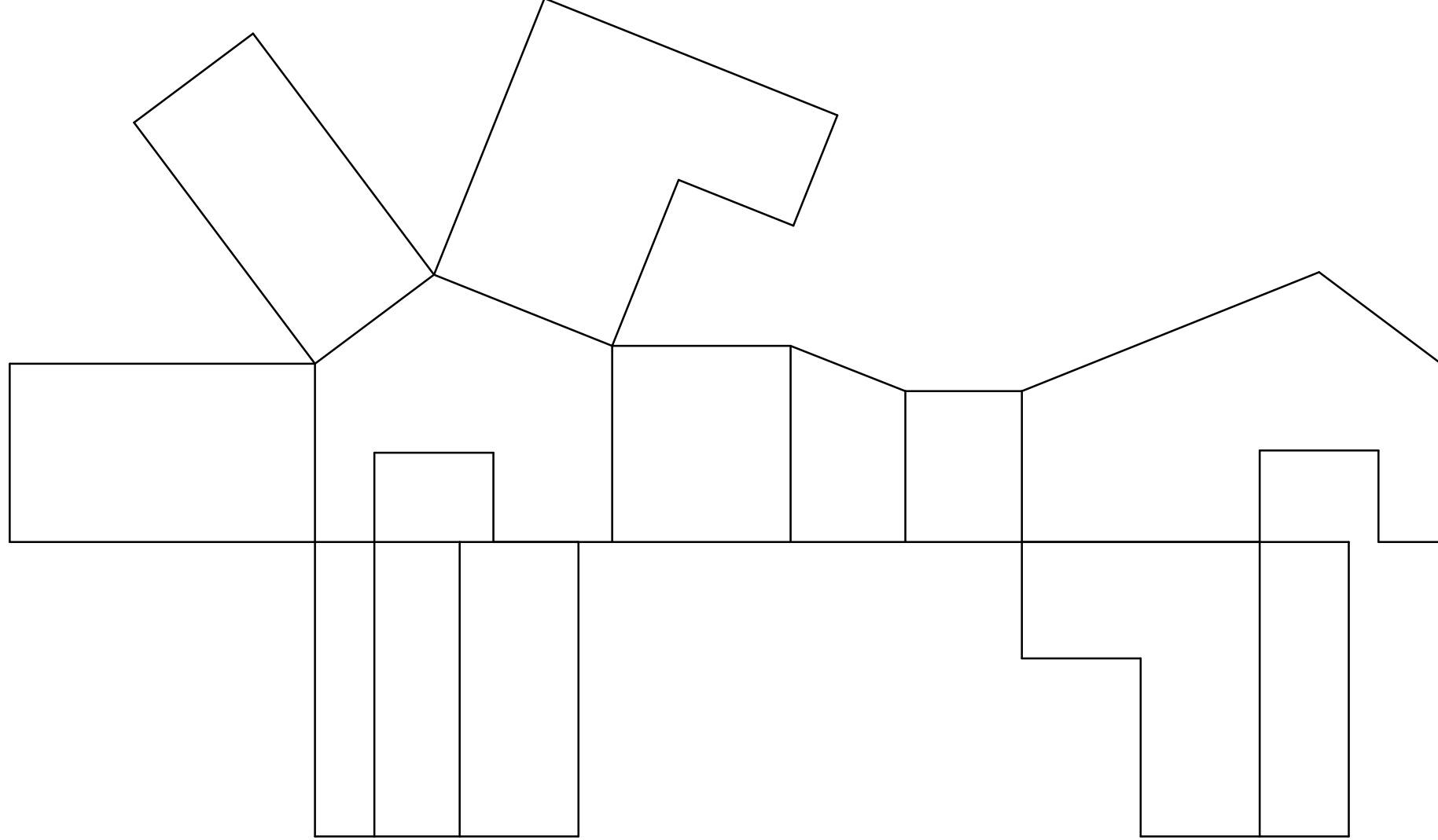

GEOMETRIA DESCRIPTIVA

Nº:

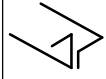

Nombre:

Cód:

Fecha:

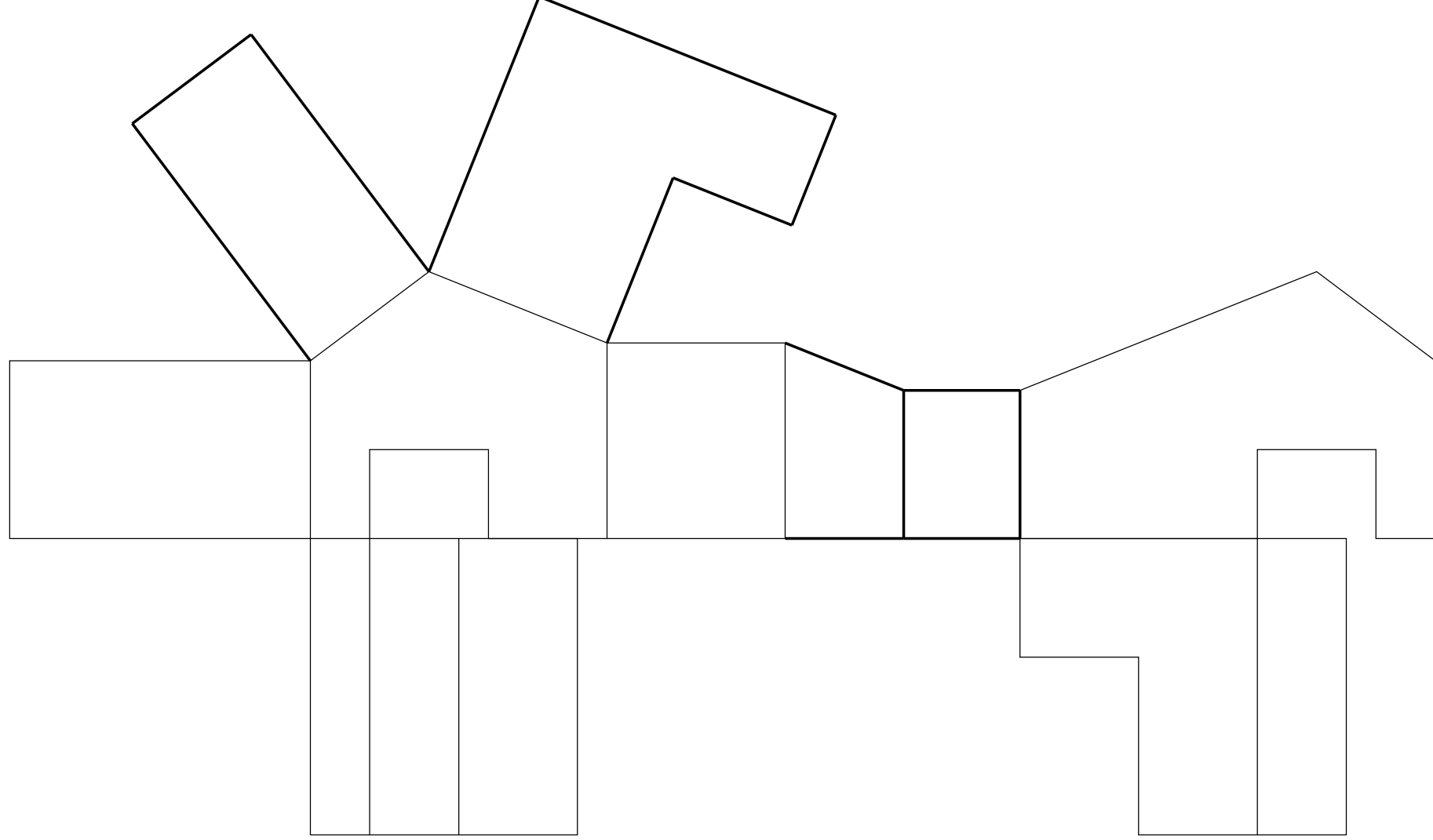

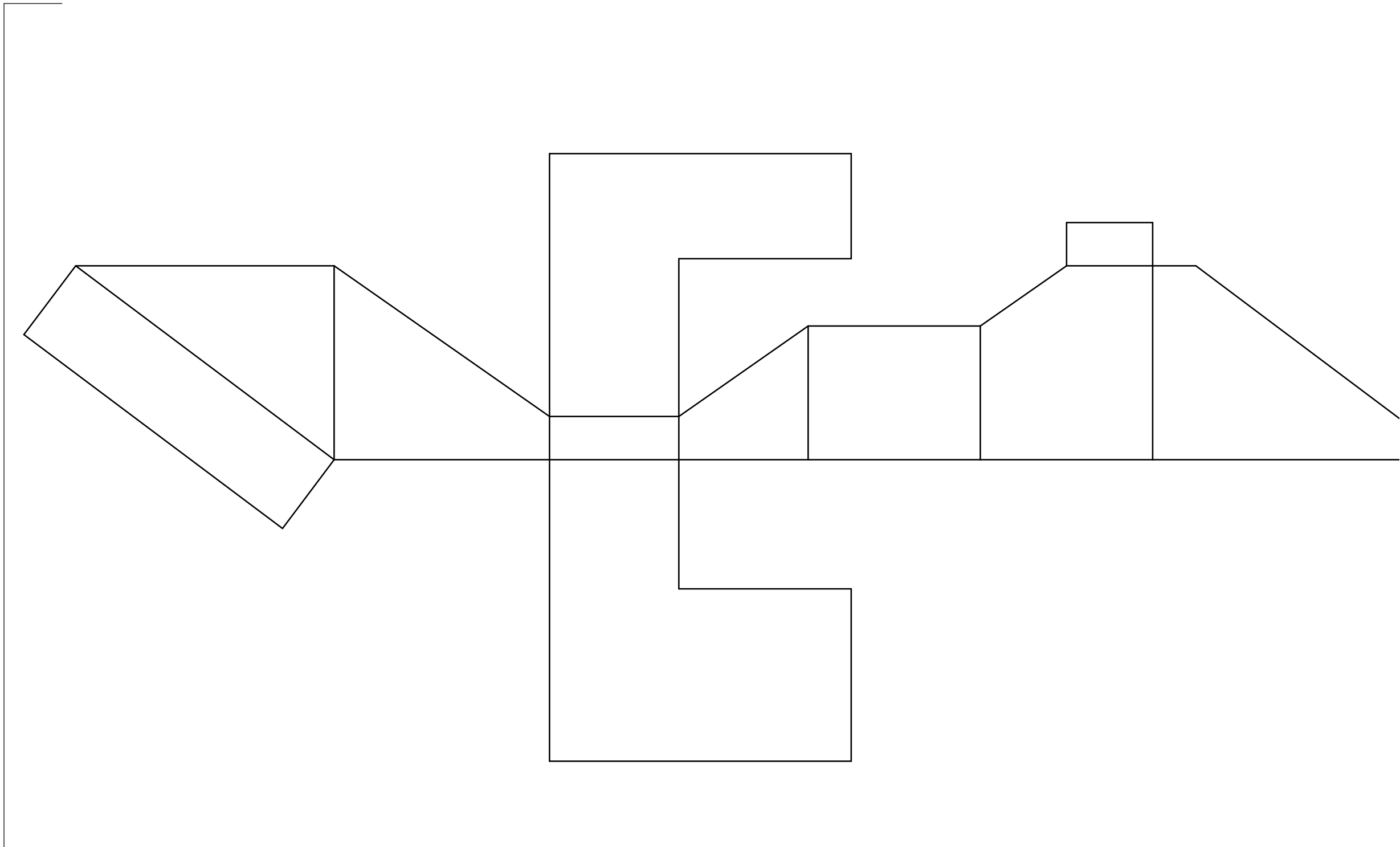

GEOMETRIA DESCRIPTIVA

Nº:

Nombre:

Cód:

Fecha:



Docente:
German E. Vargas

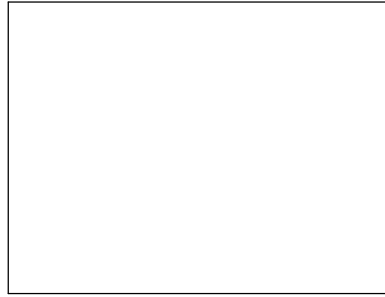
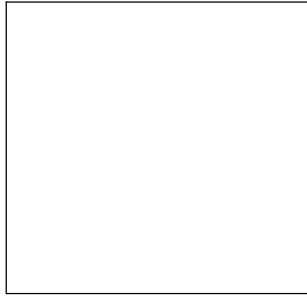
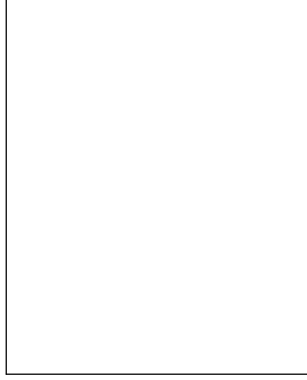
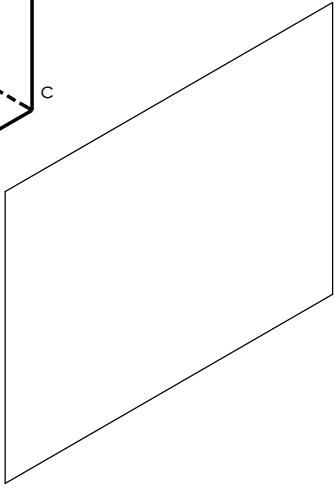
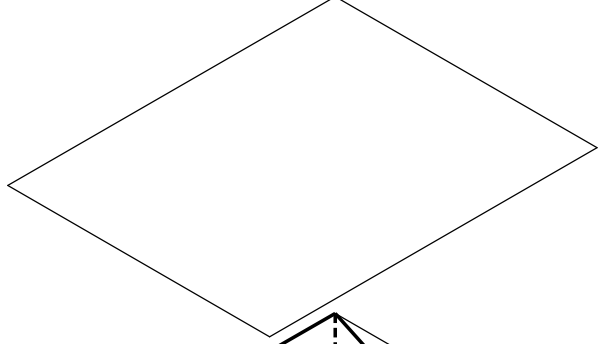
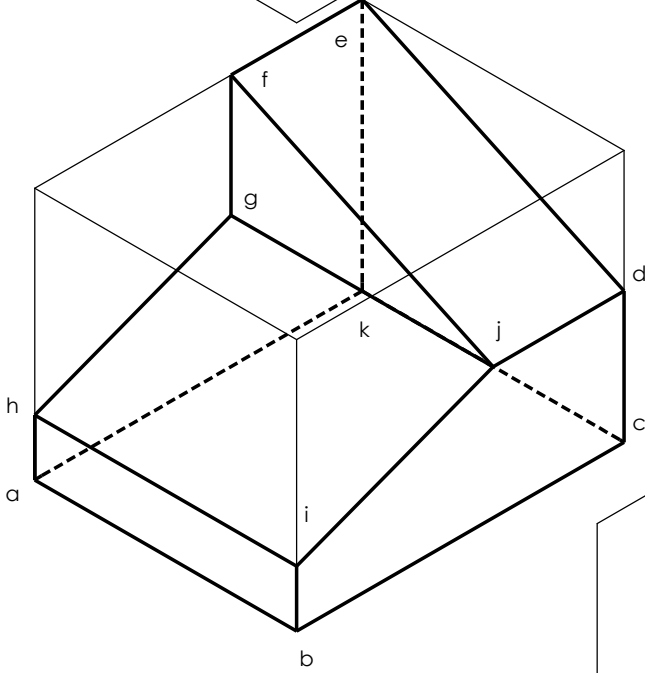
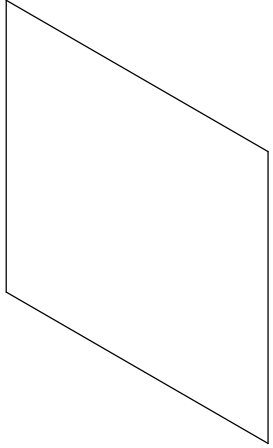

GEOMETRIA DESCRIPTIVA

Nº:

Nombre:

Cód:

Fecha:



Docente:
German E. Vargas

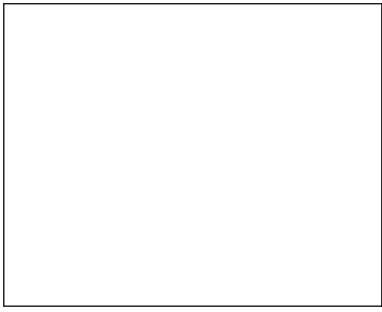
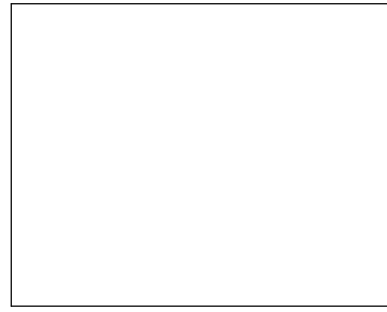
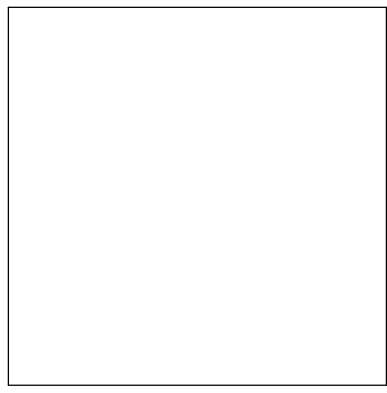
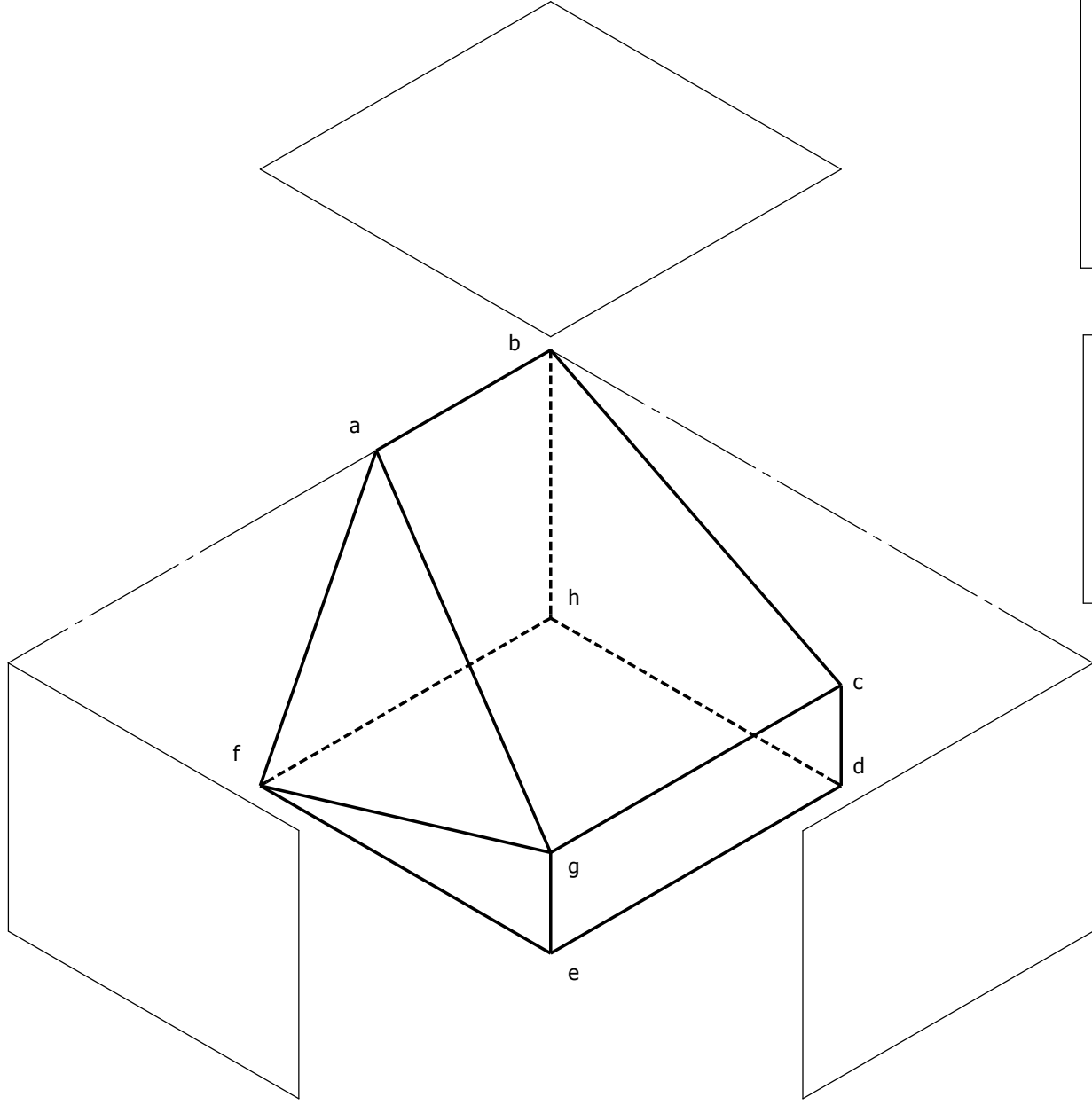

GEOMETRIA DESCRIPTIVA

Nº:

Nombre:

Cód:

Fecha:



Docente:
German E. Vargas

Blank area for student information.

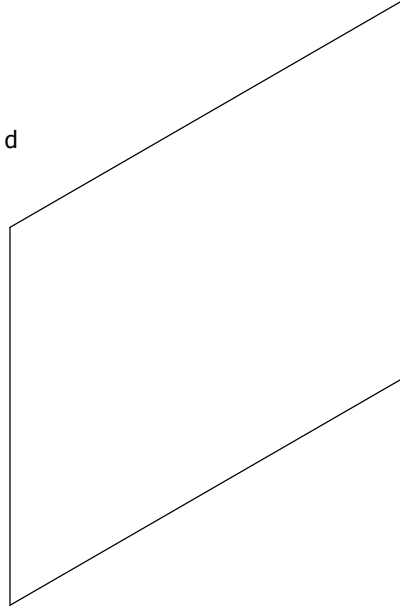
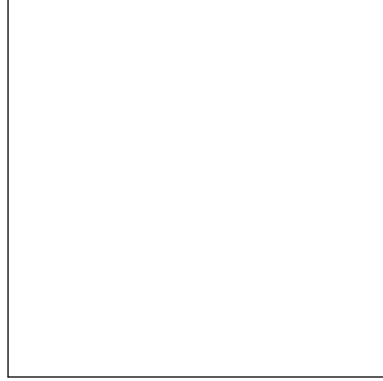
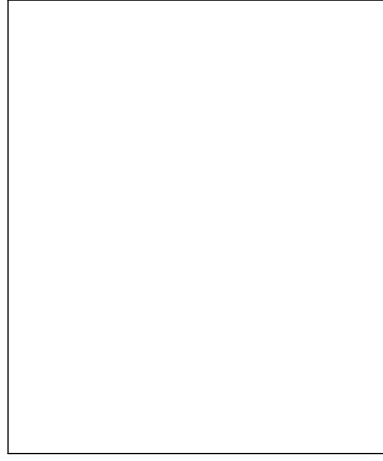
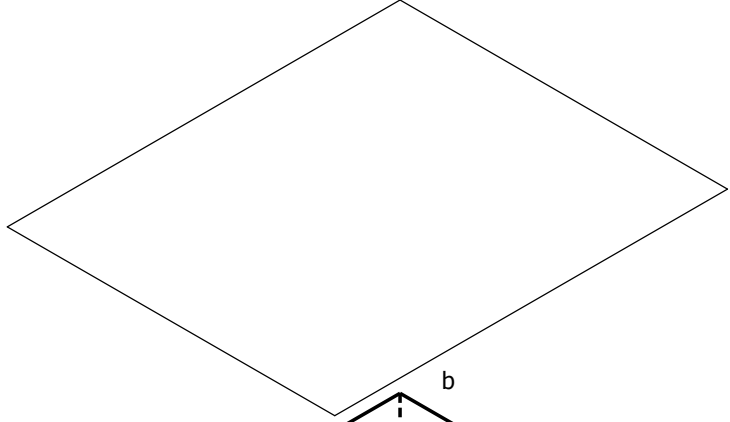
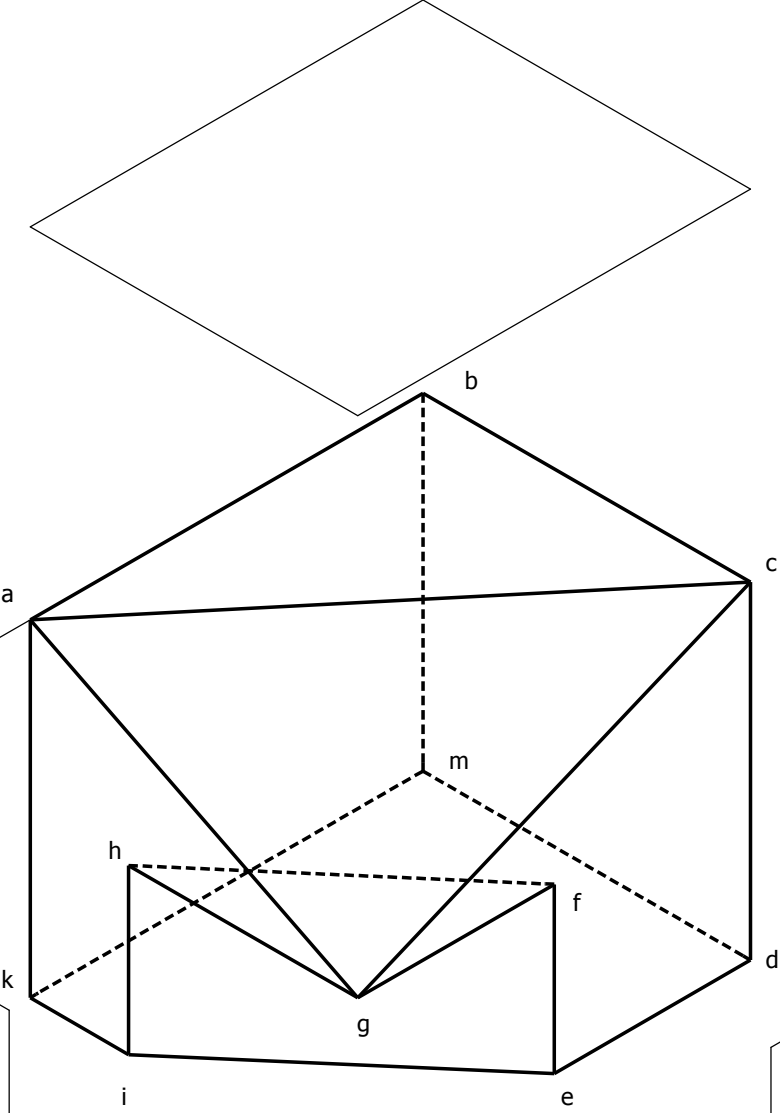

Blank area for student information.

GEOMETRIA DESCRIPTIVA

Nº:

Nombre:

Cód:

Fecha:



Docente:
German E. Vargas

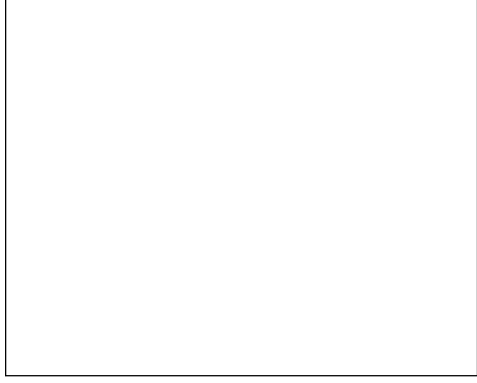
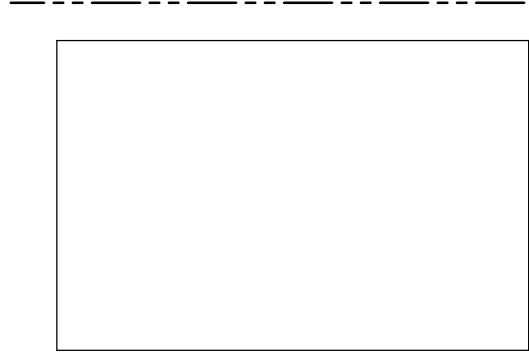
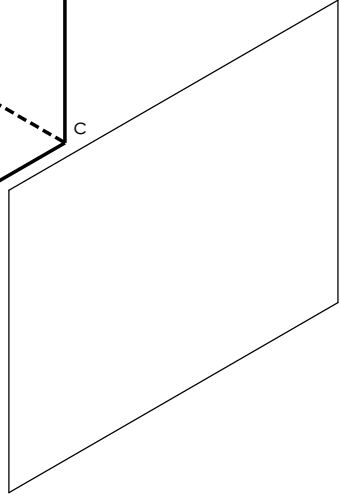
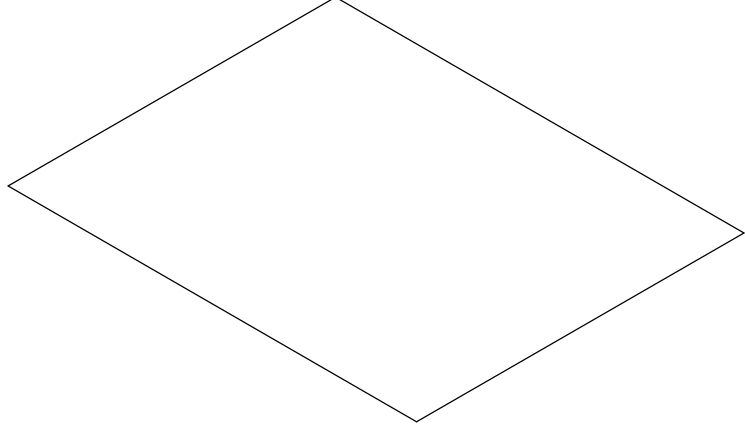
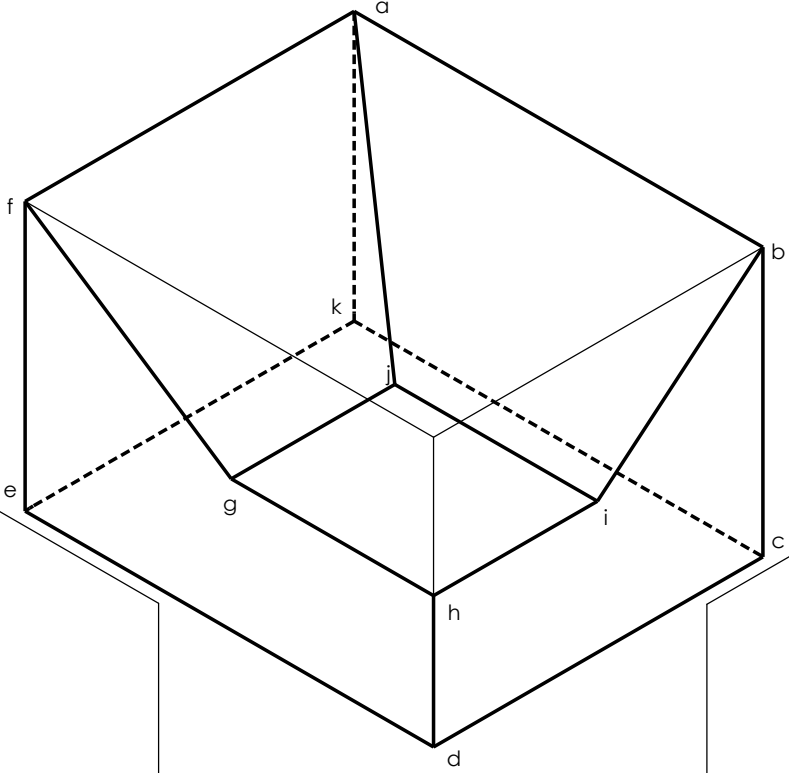
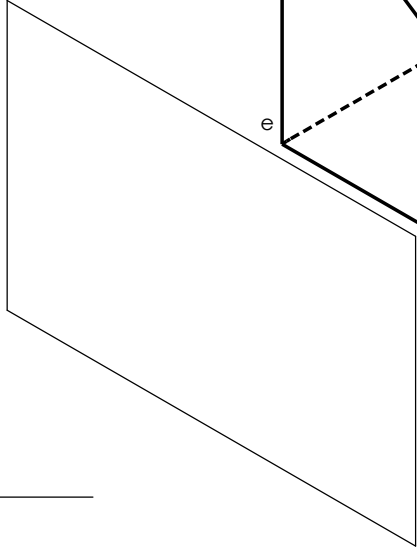

GEOMETRIA DESCRIPTIVA

Nº:

Nombre:

Cód:

Fecha:



Docente:
German E. Vargas

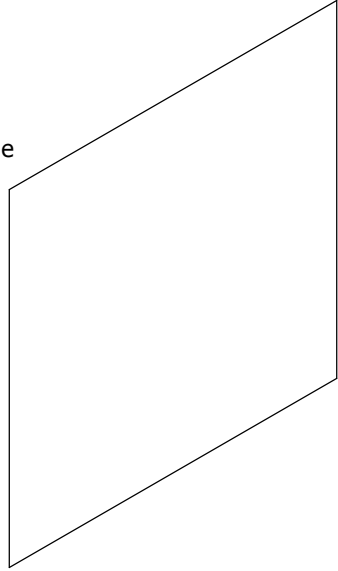
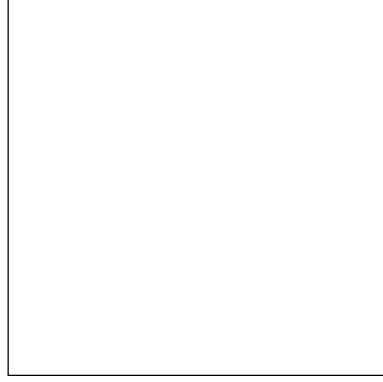
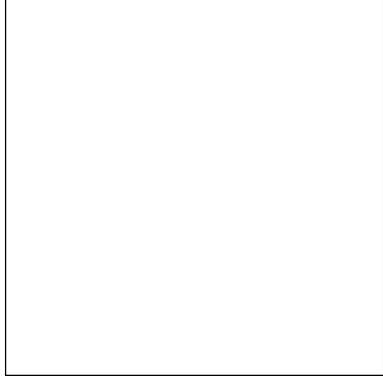
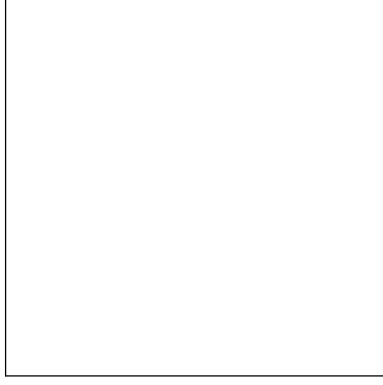
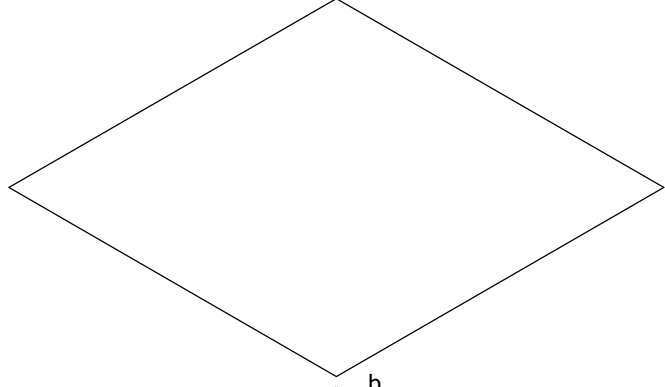
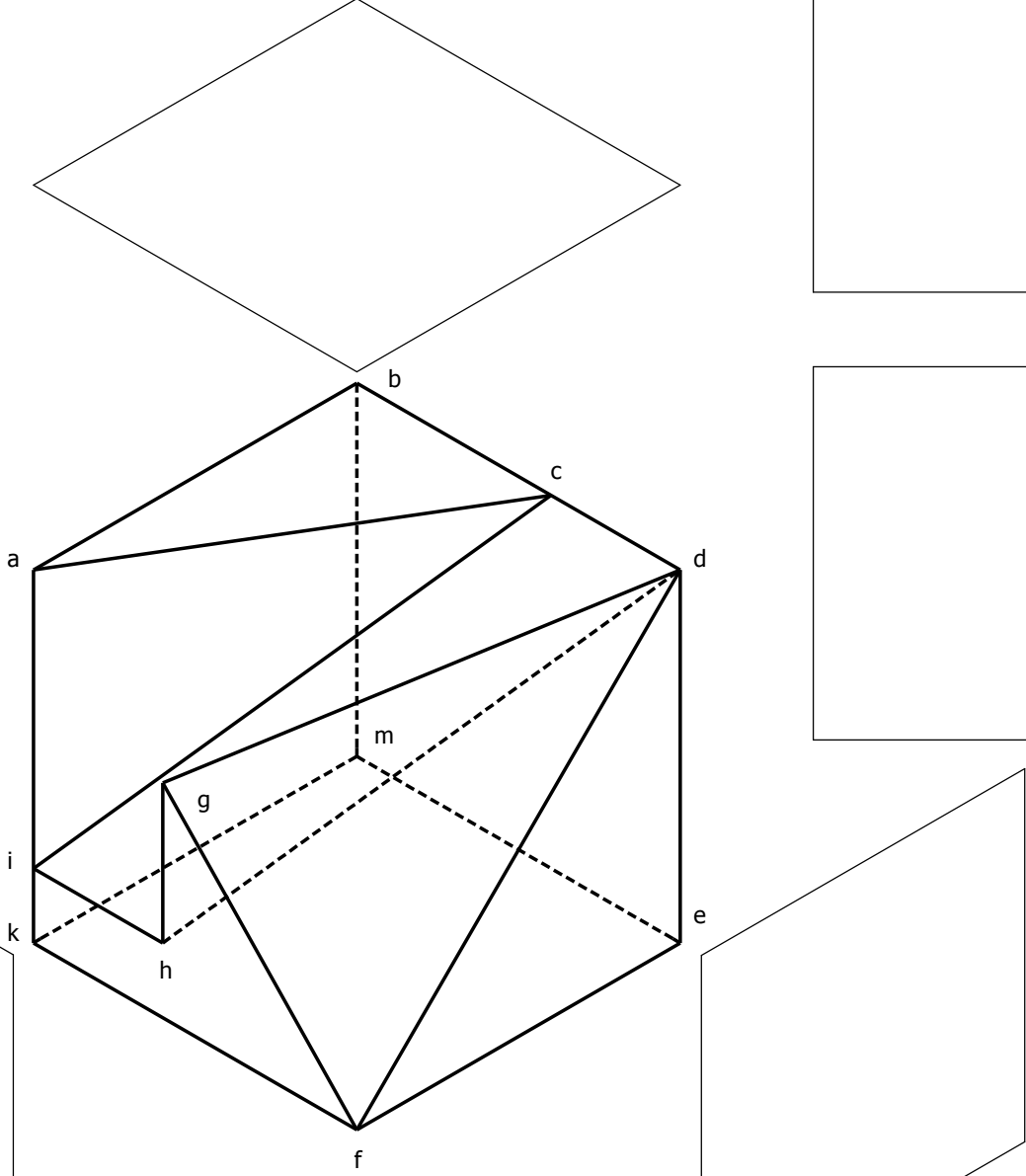
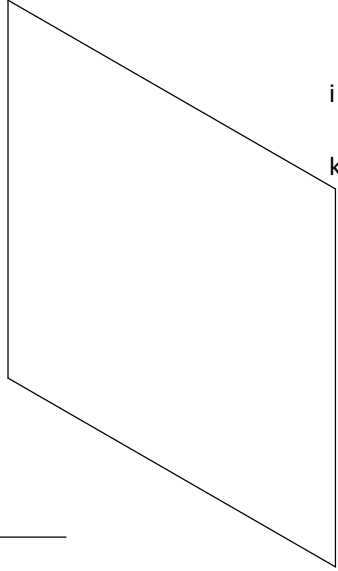

GEOMETRIA DESCRIPTIVA

Nº:

Nombre:

Cód:

Fecha:



Docente:
German E. Vargas

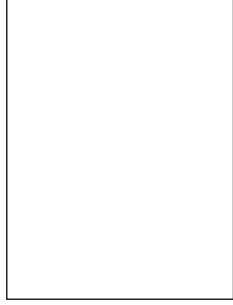
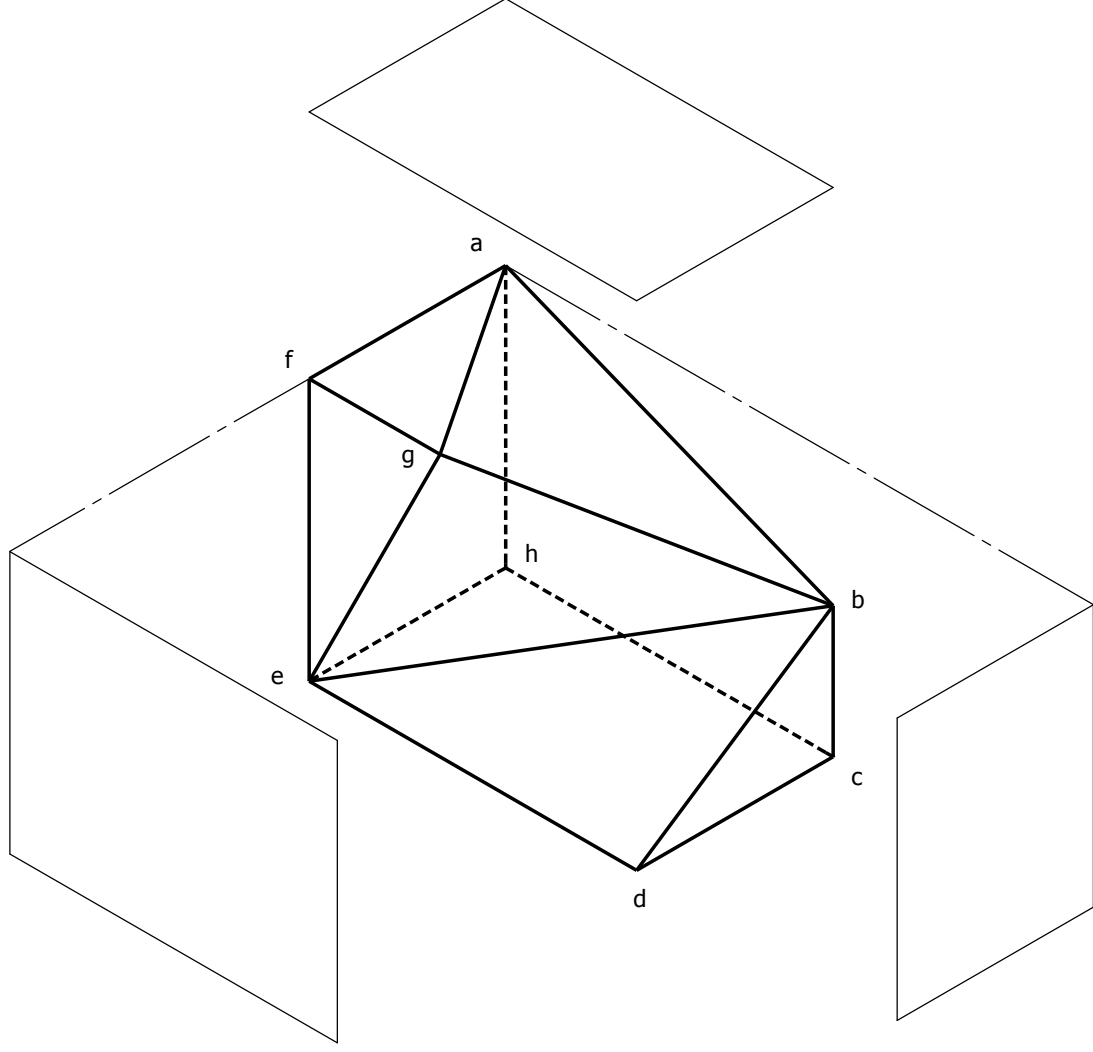

GEOMETRIA DESCRIPTIVA

Nº:

Nombre:

Cód:

Fecha:

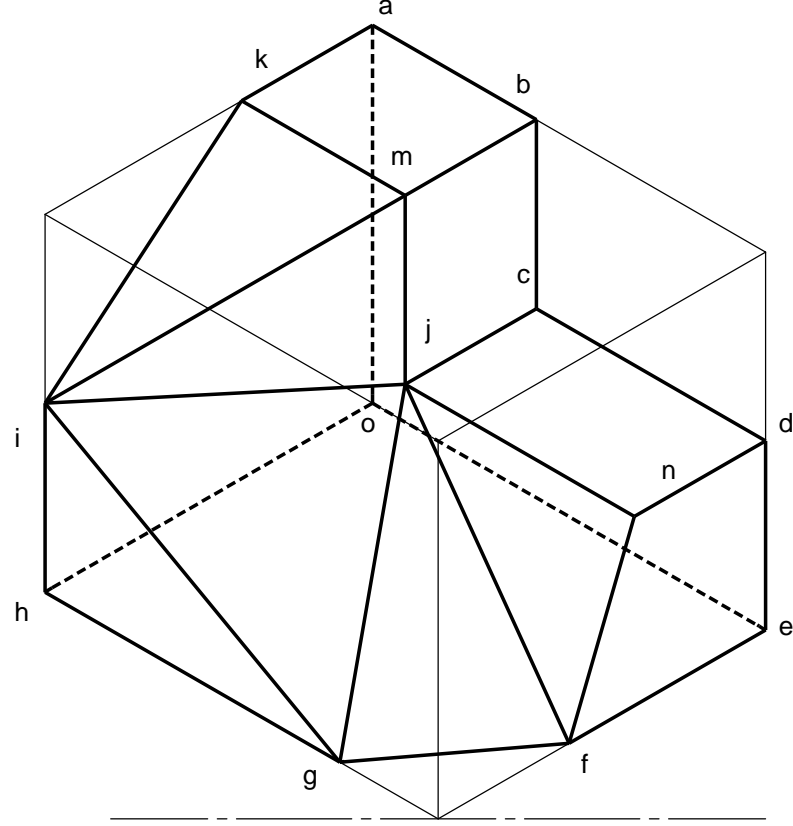
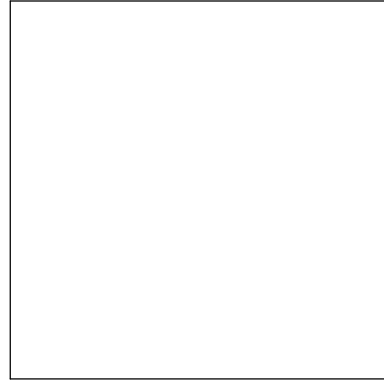

GEOMETRIA DESCRIPTIVA

Nº:

Nombre:

Cód:

Fecha:



Docente:
German E. Vargas

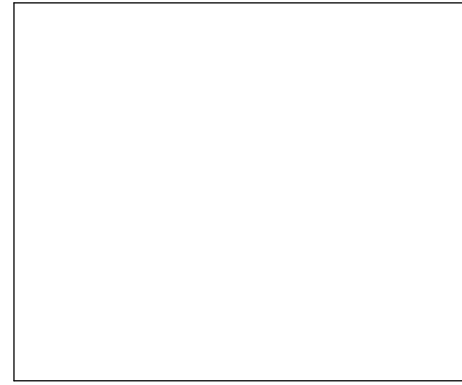
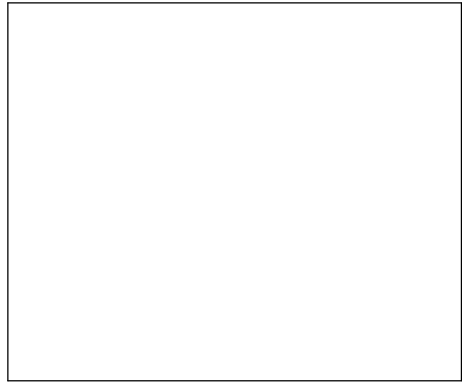
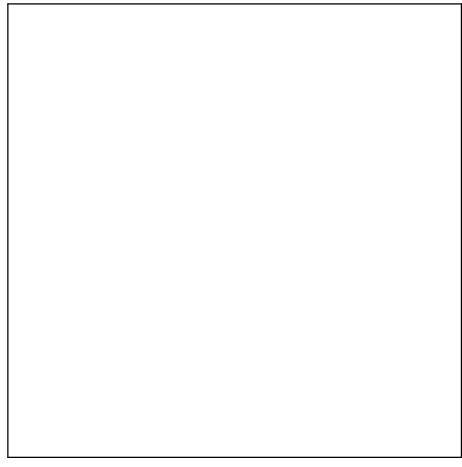
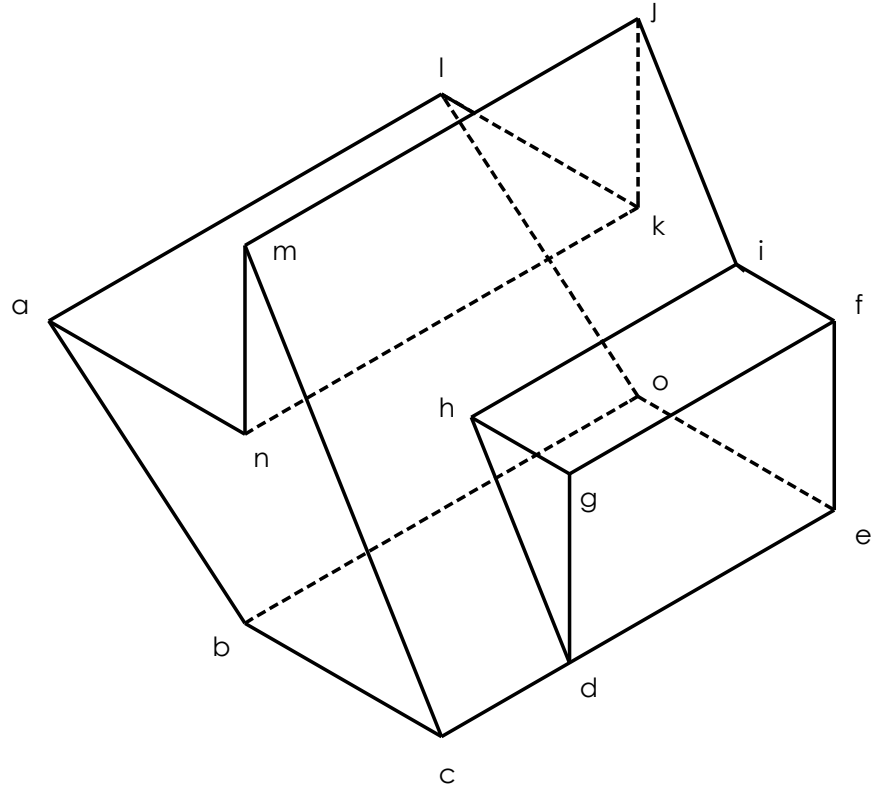

GEOMETRIA DESCRIPTIVA

Nº:

Nombre:

Cód:

Fecha:



Docente:
German E. Vargas

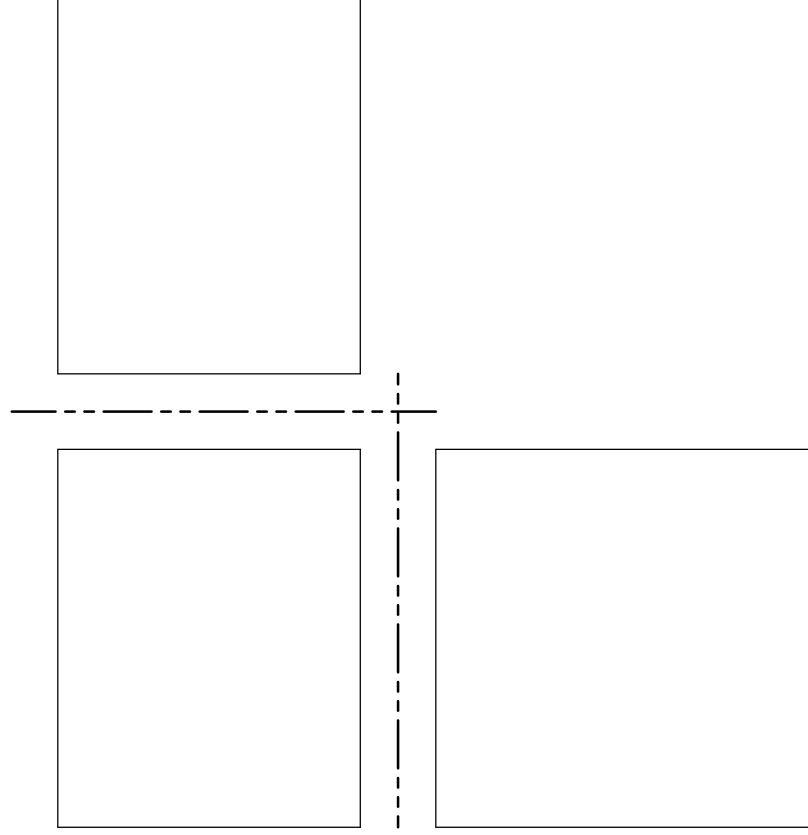
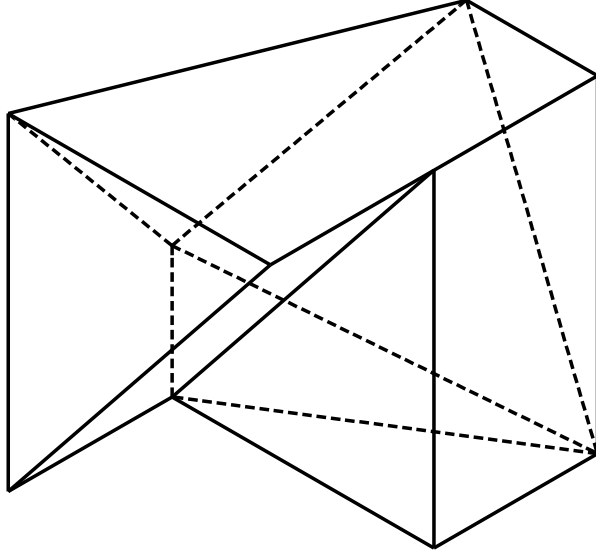

GEOMETRIA DESCRIPTIVA

Nº:

Nombre:

Cód:

Fecha:

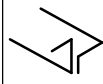

--	--

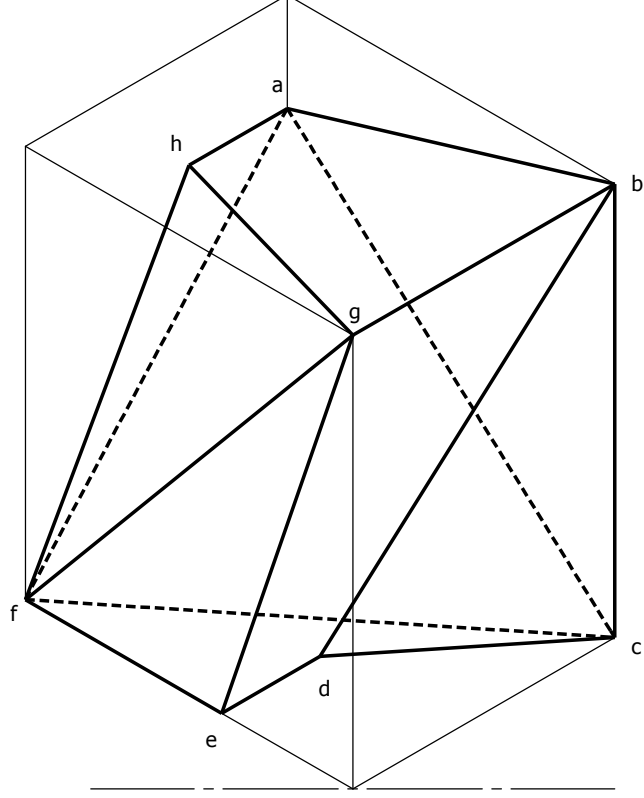

GEOMETRIA DESCRIPTIVA

Nº:

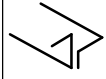

Nombre:

Cód:

Fecha:

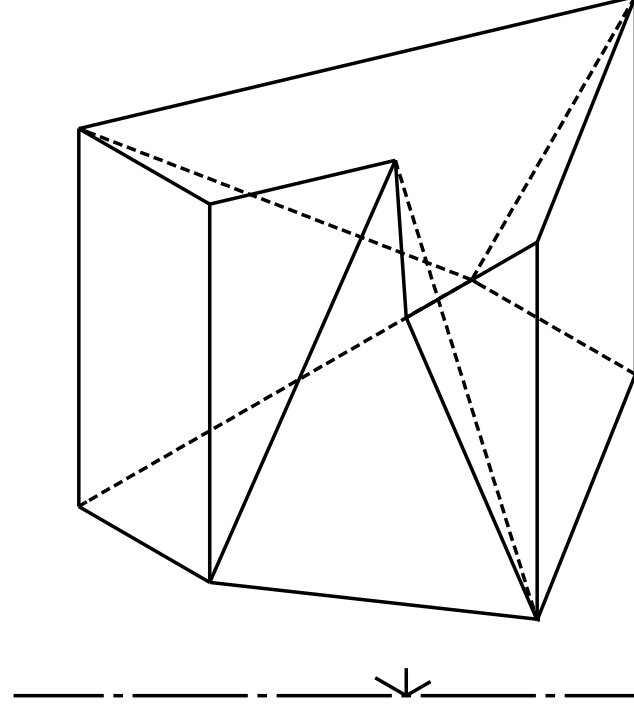

GEOMETRIA DESCRIPTIVA

Nº:



Nombre:

Cód:

Fecha:

Blank area for drawing or notes.

